

OPERATING INSTRUCTIONS

AM/FM STEREO TUNER AMPLIFIER

SANSUI 5000A



Sansui[®]

SANSUI ELECTRIC COMPANY LIMITED

Thank you for selecting the Sansui 5000A AM/FM Multiplex Stereo Tuner Amplifier. You have made an excellent choice, one that promises you years of rich stereo enjoyment.

As the world's foremost audio-only specialist, Sansui has spared no effort in making the 5000A the most powerful, most versatile and most sophisticated receiver available at its price. With an unprecedented 180 watts in power, the latest FET and IC components, functional black face front panel design and an ability to handle up to four tape recorders and three speaker systems at a time, the 5000A considerably advances the art of stereophonic reproduction.

Before leaving our factory, your new 5000A was tested, inspected and certified to be in perfect operating condition. It is now up to you to keep it that way.

This manual has been prepared to guide you in installing and operating the receiver correctly. It contains some very helpful information on making antenna connections, using controls properly and operating components most effectively. Please read it carefully before operating the receiver and retain it for future reference.

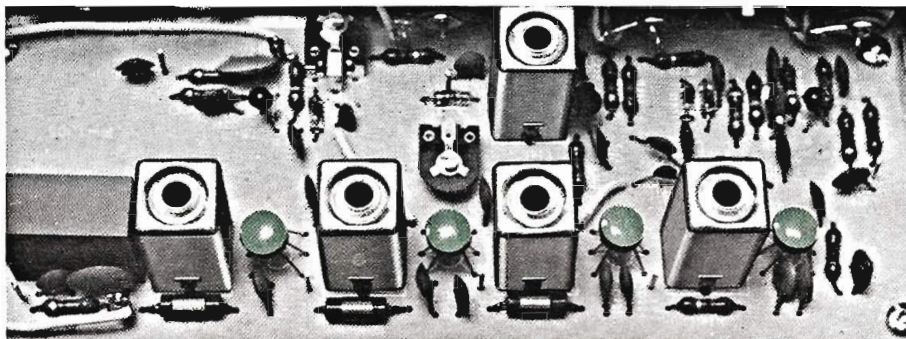

CONTENTS

SWITCHES AND CONTROLS	3, 4, 5, 6
SPEAKER CONNECTIONS	7, 8
OPERATIONS	
RADIO RECEPTION	9, 10
RECORD PLAYING	11, 12
TAPE PLAYBACK, TAPE RECORDING	13, 14, 15, 16
MAINTENANCE.....	17, 18, 19, 20
SPECIFICATIONS	21, 22
CHARACTERISTICS	21, 22



SWITCHES AND CONTROLS

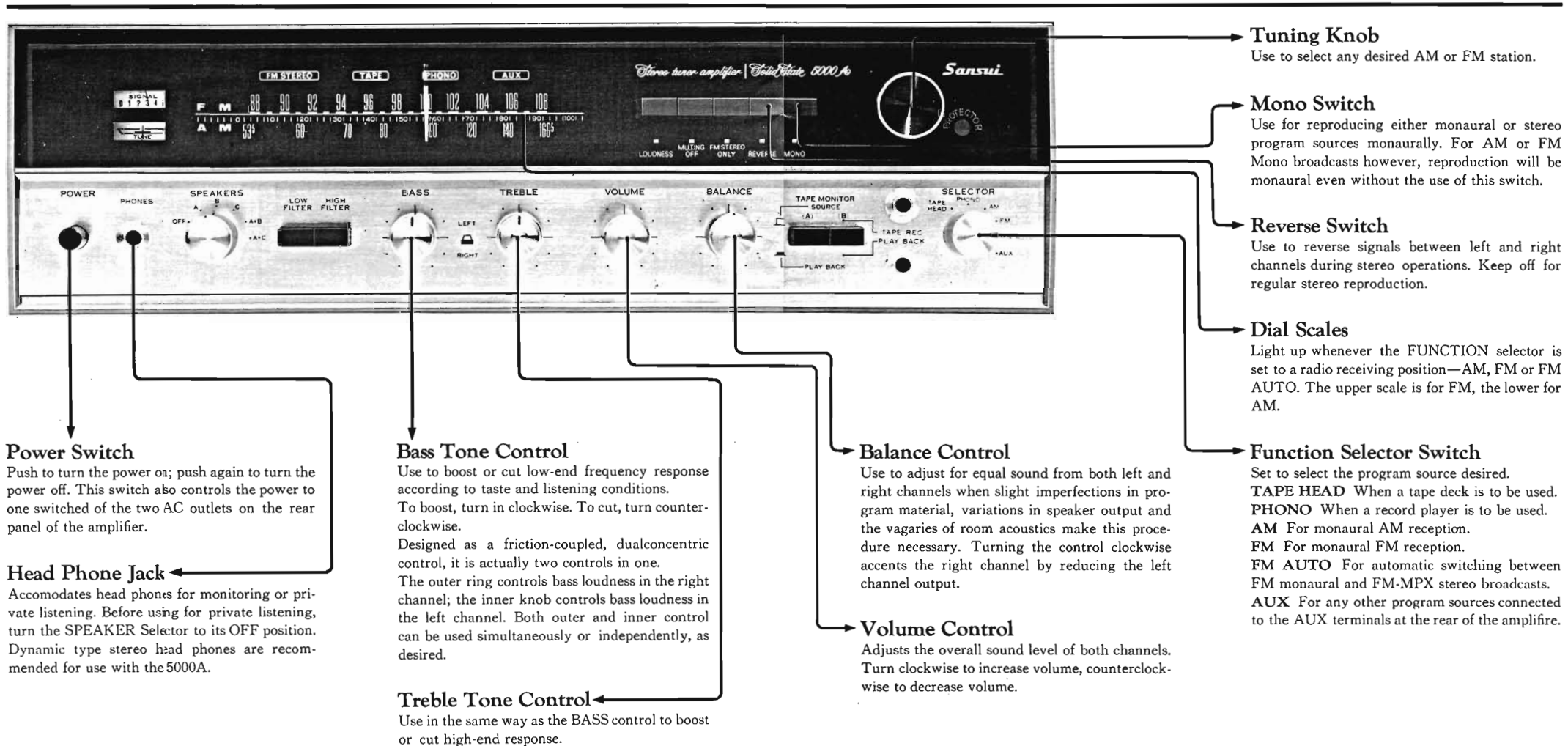

SWITCHES AND CONTROLS



Speaker Selector Switch

Allows the following selections between three speaker systems:

A Use When only the speaker system connected to the speaker terminal SYSTEM A on the rear panel of the amplifier is to be operated.

B When only the speaker system connected to the speaker terminal SYSTEM B is to be used.

C When only the speaker system connected to the speaker terminal SYSTEM C is to be used.

A+B When both speaker systems connected to speaker terminals SYSTEM A and SYSTEM B are to be operated simultaneously.

A+C When both speaker systems connected to speaker terminals SYSTEM A and SYSTEM C are to be used.

OFF Use to cut off sound from all speaker systems for private headphone listening.

FM Stereo Indicator

Lights up red when the dial pointer crosses a station making an FM-MPX broadcast and receiver is properly set for stereo reception.

High Filter Switch

Eliminates or reduces high-frequency noise such as surface noise from old or worn records, tape hiss and radio noise caused by interference from nearby electrical appliances. Use only when needed. At all other times, keep off.

Low Filter Switch

Use to eliminate or reduce low-frequency disturbances such as turntable rumble.

Tape Recorder Jacks

Upper jack is for recording, the lower jack for playback. Use for tape recorders with microphone plugs.

Tape Monitor Switches

Control the 5000A's A and B tape monitor circuits. Detailed information on usage is given Operations, p. 15.

Loudness Switch

Use to boost bass and treble response at low volume listening levels. Due to the sensitivity of human hearing, both bass and treble seem greatly reduced at low listening levels. This switch compensates for this apparent loss.

Tuning Meters

Aid in pinpointing stations. Use both to pinpoint FM stations; the upper signal meter only for best AM reception.

For FM stations: Turn TUNING knob until needle in upper meter swings as far to the right as possible. Then, watching the lower meter, turn the TUNING knob until the needle is perfectly centered.

For AM stations: Use only the upper meter and tune as for FM.

Function Indicator

Indicates in various colors whatever function the 5000A is programmed to perform. TAPE HEAD is illuminated in blue, PHONO in green and AUX in yellowish green when FUNCTION Selector is set to corresponding positions.

Protector Indicator

Lights up when Protector circuit is activated to protect transistors from damage caused by over-currents. As soon as this indicator lights up, turn off the POWER switch and take remedial action. See Maintenance, p. 19.

FM STEREO ONLY Switch

Use when only FM-MPX broadcasts are desired. Cuts out all monaural broadcasts.

Muting Switch

Eliminates interstation tuning noise. It should be used sparingly. When tuning in a weak station, it should be kept off.

SPEAKER CONNECTIONS

Connecting a Single Speaker System

Connect it to the speaker terminal labeled SYSTEM A on the rear panel of the amplifier. The two jacks on the left of the terminal accommodate the left speaker cords; the pair of jacks on the right, the right speaker cords. Be sure the polarities (+ and -) of the speaker cords and the jacks match. To actually connect a speaker cord to a corresponding jacks, push the jack button down and hold with one hand, insert the end wires of the speaker cord into the hole with the other hand, and release the button. When the system has been properly connected, set the SPEAKER Selector on the front panel to the SYSTEM A position. It is then ready for operation.

Connecting Additional Speaker Systems

Following the same procedure indicated above, one or two more speaker systems can be connected to the 5000A by utilizing the speaker terminals SYSTEM B and SYSTEM C respectively.

Each of the three systems can be operated independently with the SPEAKER Selector switch on the front panel. In addition, speaker systems A and B can be operated simultaneously when the SPEAKER Selector is set at the A+B position, and speaker systems A and C can be operated simultaneously when the Selector is set at the A+C position.

If Speaker Polarities Are Not Properly Matched . . .

If the polarities (+ and -) of the speakers and the amplifier are not matched correctly, sound cancellation at some frequencies or in some listening position occurs. Particularly when listening to monaural reproduction, this condition is noticeable by an absence of sound at a point midway between right and left speakers. If this situation occurs, check the amplifier and speaker connections once more and reverse the connections between the amplifier and either the right or left speaker.

Connections to the A, B and/or C Speaker System Terminals

1. For use with a 4-ohm speaker system, connect it to any one of the A,B and C speaker system circuits.

CAUTION: Never attempt to use two or three 4-ohm speaker systems at the same time.

2. For use with the three speaker systems, the impedance must be more than 4 ohms each.

3. For use with the two speaker systems (A+B or A+C), the combined impedance of the A+B or A+C systems must be more than 4 ohms.

OUTPUT LEVEL ADJUSTOR
 (Sub output volume control.)
 See "MAINTENANCE" at page. 18

SPEAKER DAMPING FACTOR
 Switch (See "MAINTENANCE"
 at page. 18)

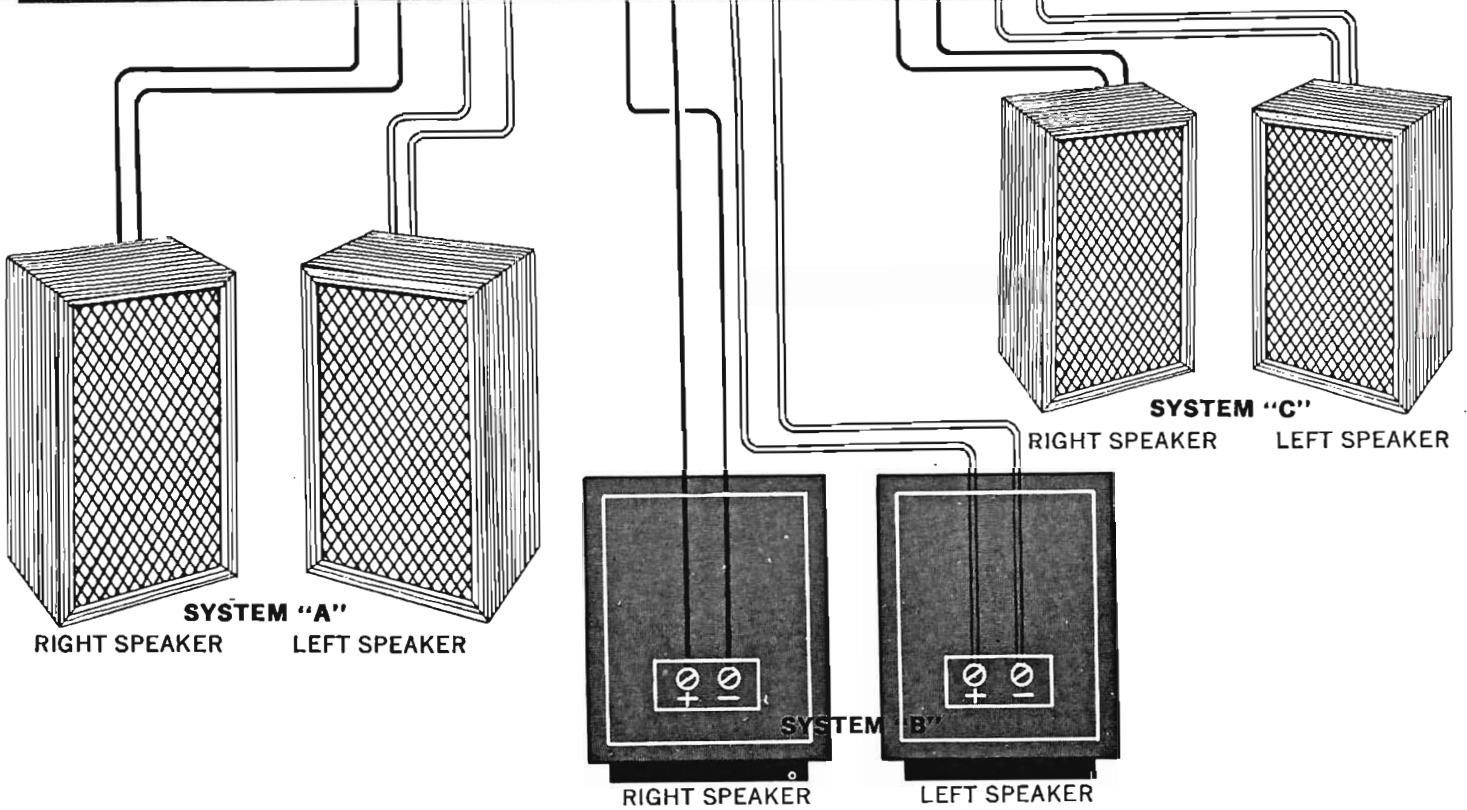
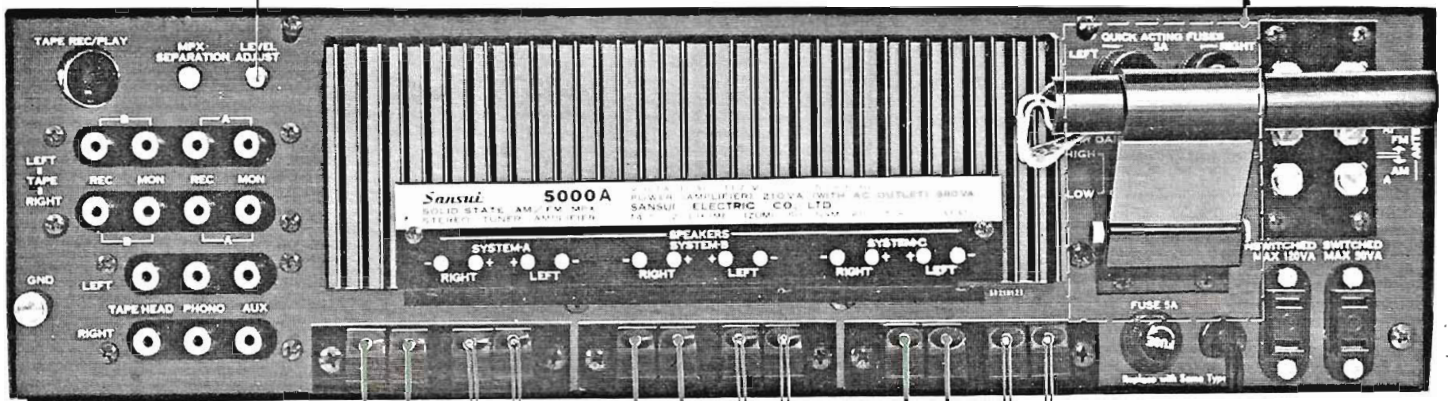
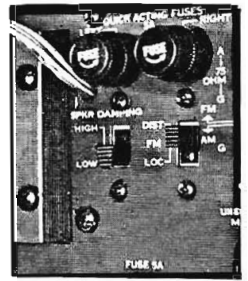

OPERATIONS

RADIO RECEPTION

The quality of reception that can be expected from the 5000A is largely dependent on the correct positioning and use of antennas. The following procedures are recommended for noise-free reception.

FM Antenna

Where FM broadcasting stations are near and FM signals are strong, satisfactory FM reception can be obtained by using the feeder wire accompanying the amplifier. Connect the feeder wire to the antenna terminals marked FM-A₁ and FM-A₂ on the rear panel, then fully extend the wire to a T form and fix it to a wall or ceiling where it allows the strongest reception.

If the 5000A is used in a thick-walled building or in an area remote from FM broadcasting stations, the indoor feeder wire antenna may be inadequate for strong signal reception. An outdoor antenna designed exclusively for FM reception should then be installed.

FM antennas of the 300 ohm balanced type and 75 ohm unbalanced type can be used with the 5000A. Connect either antenna to the matching antenna terminals on the rear of the amplifier. The 300 ohm feeder wire should be connected to the FM antenna terminals A₁ and A₂ as in Fig. 2. If a 75 ohm coaxial cable is used, connect the conductor to the FM antenna terminal A, and the shielding wire to the terminal G as in Fig. 1.

NOTE: FM sensitivity cannot be raised simply by lengthening the antenna. Adjust the antenna's height and direction while actually listening to a broadcast for the best reception.

Built-in AM Ferrite Bar Antenna

This sensitive antenna, located on the rear panel of the amplifier, is usually adequate for strong AM reception. To use, pull it down and away from the

back of the tuner until it comes to a stop halfway between the top and the bottom of the amplifier. Then move it from up to down until best reception is obtained.

Outdoor AM Antenna

In ferroconcrete buildings or in areas remote from the broadcasting station, the built-in ferrite bar antenna may be inadequate for strong AM reception. An outdoor antenna then becomes necessary. This can be accomplished by connecting the PVC wire accompanying the amplifier to the antenna terminal marked AM-A on the back panel. Run this wire to an antenna that has been installed outdoors and away from the building. At the same time, the unit should be grounded. Position the outdoor antenna where reception is strongest while actually receiving a broadcast. And, for reasons of safety, be sure to attach a lightning arrester to the outdoor antenna.

Radio Reception

FM Programs

1. Set the FUNCTION Selector to the FM or FM AUTO position, the former for only monaural broadcasts and the latter for automatic switching between monaural and stereo broadcasts. If too much noise or interference accompanies a stereo broadcast with the FUNCTION Selector set at FM AUTO, turn the Selector to the FM position and listen to the same broadcast monaurally.
2. Select the desired FM station on the FM band of the tuning dial with the TUNING knob. The station is properly pinpointed when the needle in the SIGNAL meter moves as far to the right as possible, and when the needle in the TUNE meter is centered. For all stereo broadcasts being received, the STEREO Indicator will light up in red.

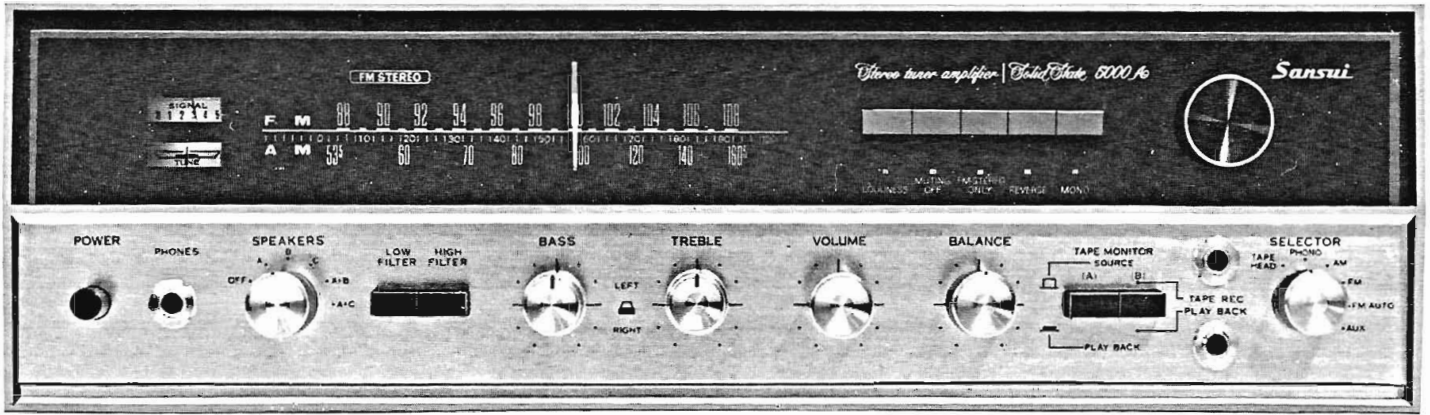

3. When a stereo broadcast is being received, use the BALANCE knob to control the balance of sound for both left and right channels. Use all other controls and switches according to taste and listening conditions.
4. To listen to FM-MPX stereo broadcasts exclusively, set the FM STEREO ONLY switch to its ON position. This automatically cuts out all FM monaural broadcasts and enables the operator to find stations broadcasting stereo programs more rapidly. When using this switch, be sure that all other pertinent switches are set for stereo reception.

AM Programs

1. Set the FUNCTION Selector to the AM position.
2. Select the desired station on the AM band of the tuning dial with the TUNING knob. The station is properly tuned when the needle in the SIGNAL meter moves as far to the right as possible. The lower TUNE meter does not operate for AM broadcasts and should be ignored.
3. Use all other controls and switches as required. During AM reception, the right and left speakers produce the same sounds whether the REVERSE and MONO switches are on or off.

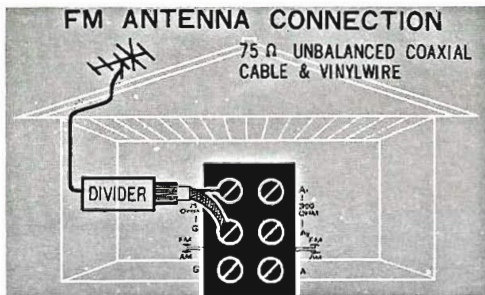

Fig. 1

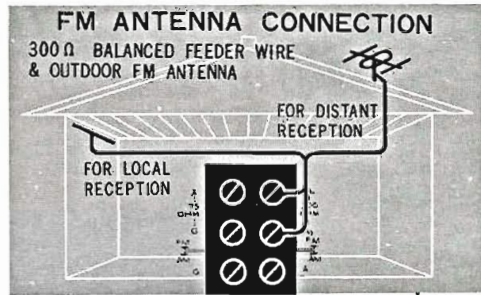
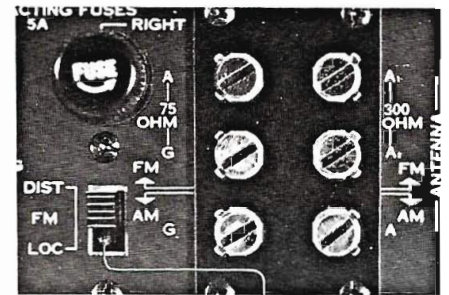

Fig. 2



FM ANTENNA LOCAL/DISTANT switch
See "MAINTENANCE" page. 18

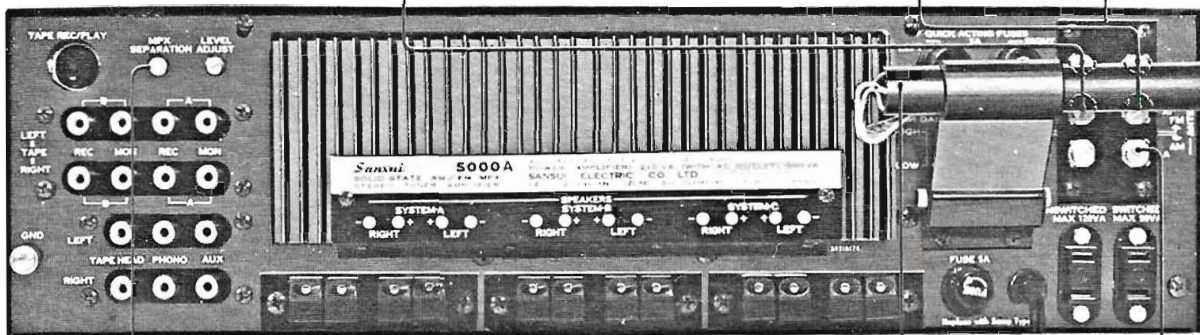

Fig. 3

FM MPX SEPARATION
See "MAINTENANCE" page. 18

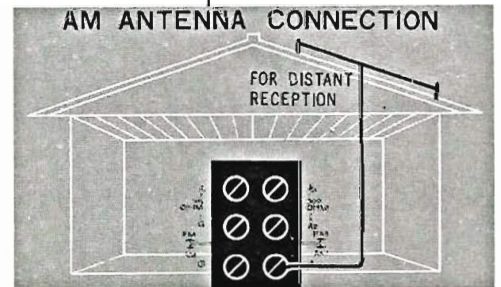
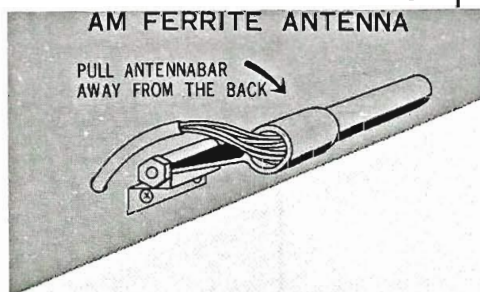

Fig. 4

OPERATIONS

RECORD PLAYING

Record Player Connections

The following procedures are recommended for use with a player or turntable utilizing a magnetic cartridge with an output voltage between 2 mV and 10 mV:

1. Connect the left channel output of a stereo turntable to the LEFT channel (upper) PHONO input jack on the rear panel of the amplifier.
2. Connect the right channel output of the turntable to the RIGHT channel (lower) PHONO input jack.
3. If a monophonic player or turntable is used, it may be connected to either RIGHT or LEFT channel PHONO input jack.
4. Insert the power-cord plug of the player into the AC outlet labeled SWITCHED on the rear of the amplifier. The power supply for the player will then be controlled by the POWER switch on the front panel of the amplifier.

NOTE: Although it is not recommended from a standpoint of tone quality, if a player with a crystal cartridge must be used, connect the output of the player to an input jack labeled AUX on the rear of the amplifier.

Record Player Operations

1. Set the FUNCTION Selector to the PHONO position on the front panel of the amplifier. The PHONO indicator will light up green.
2. If a monaural player is used, push the MONO switch on.
3. Turn the player's power on, and select the correct speed for the record(s) to be played.
4. Place the needle on the record. When monophonic records are played on a stereo player, follow the same procedures as for stereophonic records for better results.
5. Adjust the BALANCE control to obtain equal sound from both right and left channels.
6. Use all other controls and switches according to taste and listening conditions.

Humming and Howling

Care must be taken never to place a record player on or too near a speaker enclosure. Otherwise the vibration of the speaker enclosure is transmitted to the player and causes howling. It is best to keep these components completely separated, but if this is impossible, to place a thick cushion between them.

Humming is a phenomenon caused by incomplete or incorrect player-amplifier connections. If this occurs, check to make sure that all connections are complete and that the thickness of the connecting wire is sufficient.

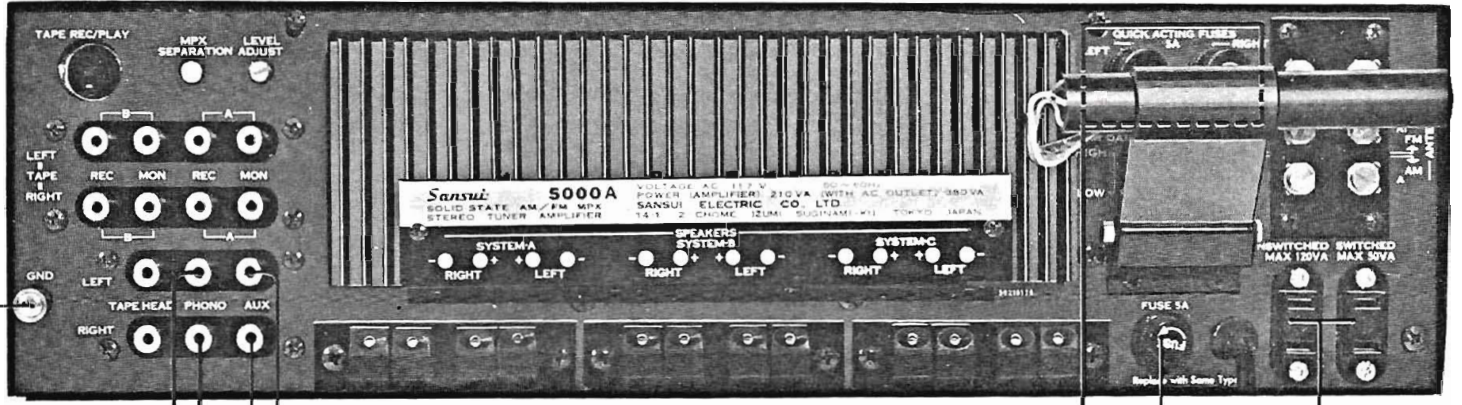
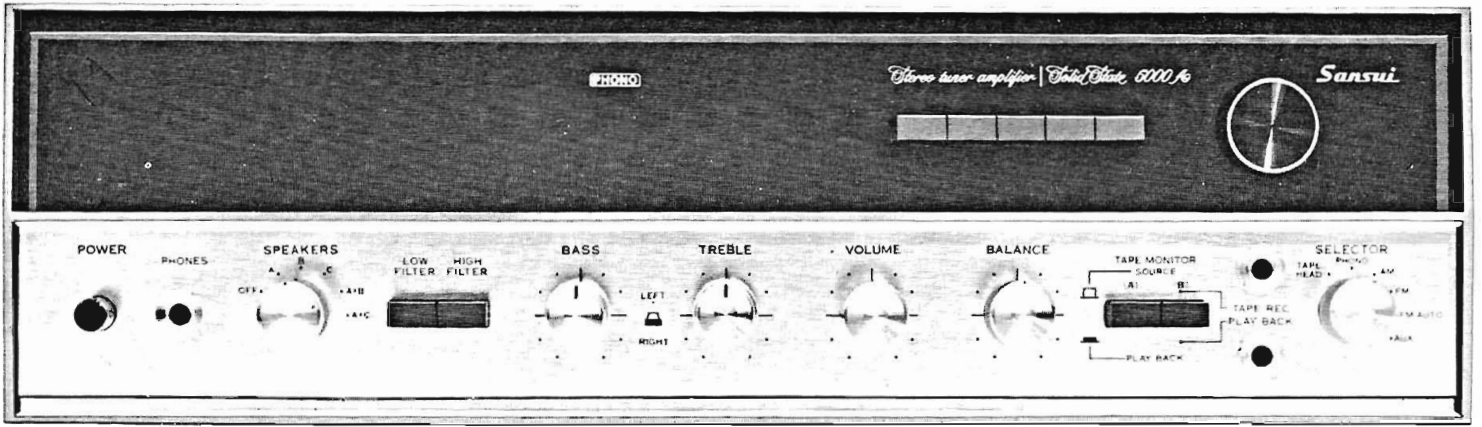

Connect the output of others

AC OUTLETS
See
"MAINTENANCE"
page. 20

POWER FUSE
5 Ampere
See "MAINTENANCE"
page. 20

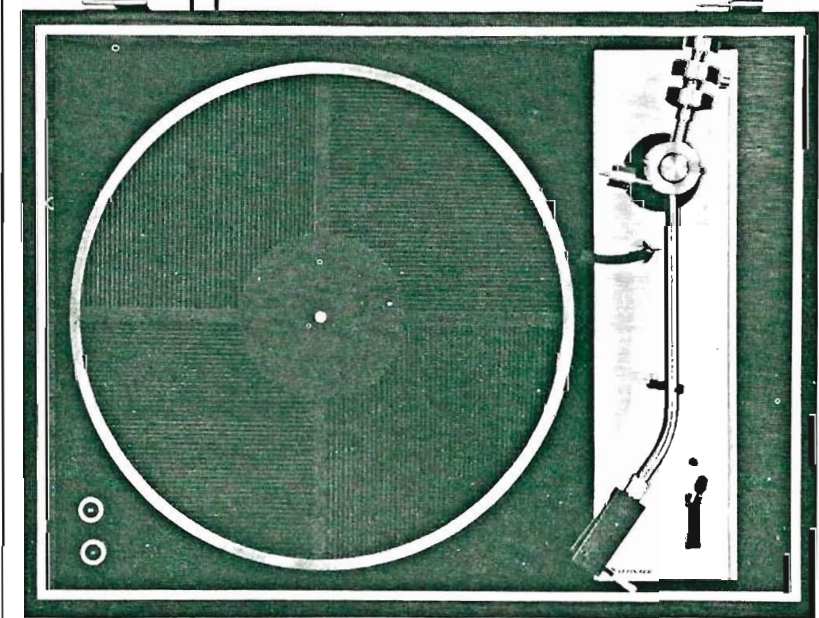

GND (Grounding) See "MAINTENANCE" page. 19

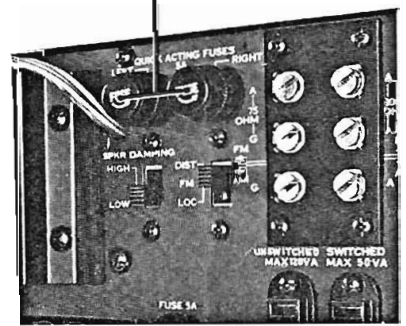

QUICK ACTING FUSES
See "MAINTENANCE"
page. 19

OPERATIONS

— TAPE PLAYBACK

— TAPE RECORDING

Tape Recorder Connections

The 5000A is equipped with two tape monitor circuits. Each circuit has two tape monitor terminals. This permits the 5000A to accommodate up to three tape recorders simultaneously for recording or playback operations, or to achieve dubbing between two of them.

Tape recorders with DIN plugs, Pin Jacks or microphone plugs may be connected to the 5000A.

DIN Plug Tape Recorder

Connect the DIN plug of this recorder by inserting it into the TAPE REC/PLAY socket near the upper left corner on the rear panel of the amplifier.

Pin Jack Tape Recorder

Connect this type of recorder by inserting the pins into a TAPE terminal on the rear of the amplifier. Both A and B monitor circuits have separate pin-jack terminals. For either circuit, connect the left and right channels of the recording input cord to the LEFT (upper) and RIGHT (lower) jacks of the REC terminal with shielded wire. Then connect the left and right output channels of the playback cord to the LEFT and RIGHT jacks of the MON terminal with shielded wire.

Microphone Plug Tape Recorder

This type of recorder is connected by inserting its plugs into the jacks located next to the tape monitor switch on the 5000A's front panel. Microphone Plugs for both monaural and stereo reproduction can be used, but in either case the recording input should be connected to the upper jack marked TAPE REC, and the playback output to the lower jack marked PLAY BACK.

Tape Deck Connections

To connect a tape deck without a built-in pre-amplifier:

1. Connect the left channel output of the tape deck to the LEFT channel (upper) terminal of the TAPE HEAD input on the rear of the amplifier.
2. Connect the right channel output of the tape deck to the RIGHT channel (lower) terminal.
3. If a monaural tape deck is used, it may be connected to either the RIGHT or LEFT channel.

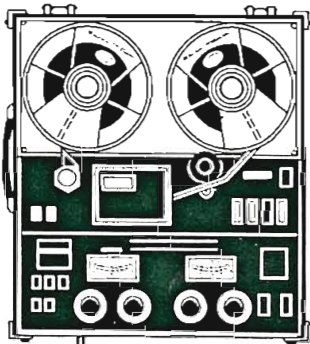

DIN Tape recorder
"A" circuit

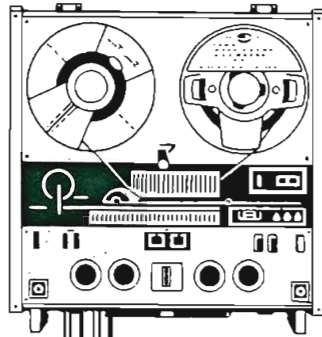

Tape recorder
"A" circuit

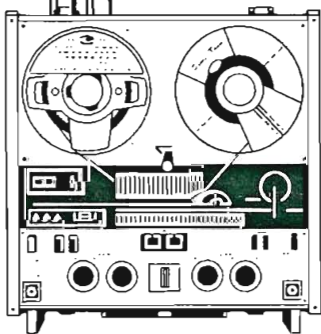
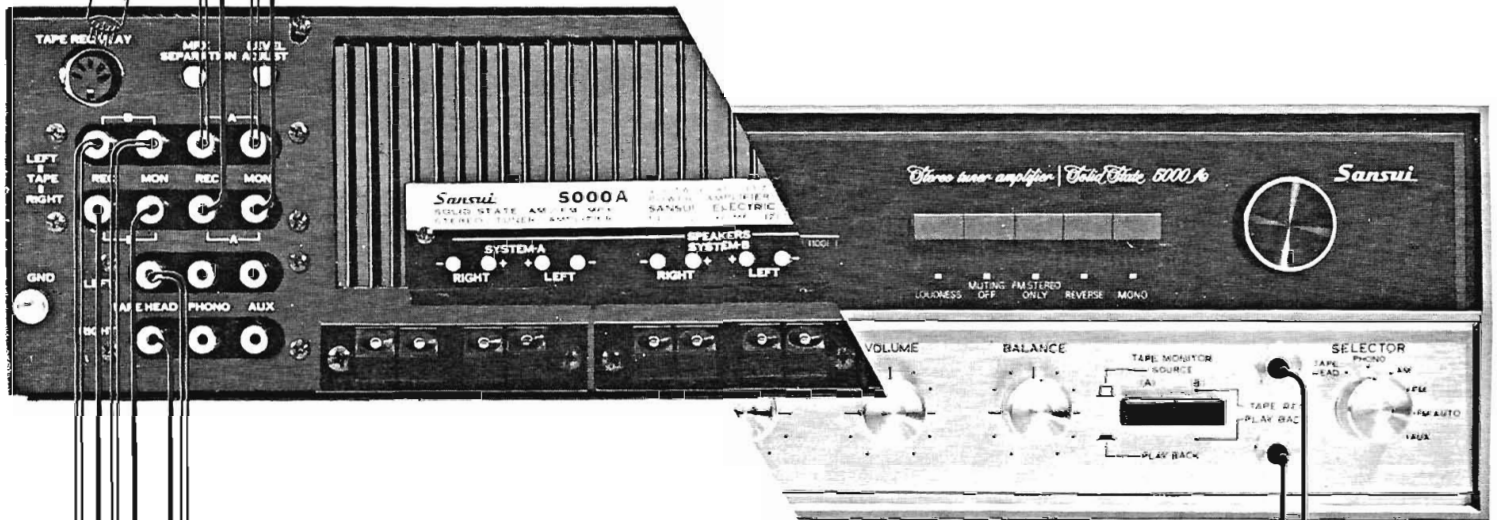

Tape recorder "B" circuit

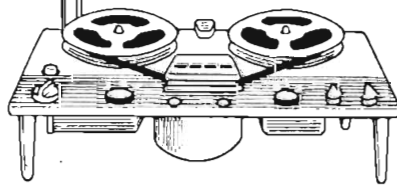

Tape deck

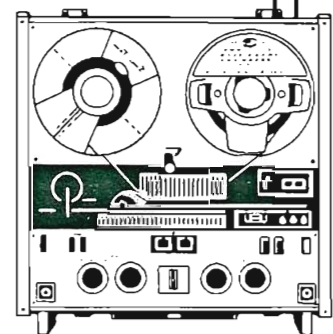

Tape recorder "B" circuit

(Microphone
plugs)

OPERATIONS

- TAPE PLAYBACK
- TAPE RECORDING

Tape Recorder Operations

The TAPE jacks on the rear panel are incorporated in two circuits, A and B. The DIN connector has been placed in parallel with circuit A, while the front panel microphone jacks are placed in parallel with circuit B. In the case of the B circuit, the corresponding pin jacks on the rear panel cannot be used if a tape recorder has been connected to the front panel microphone plugs.

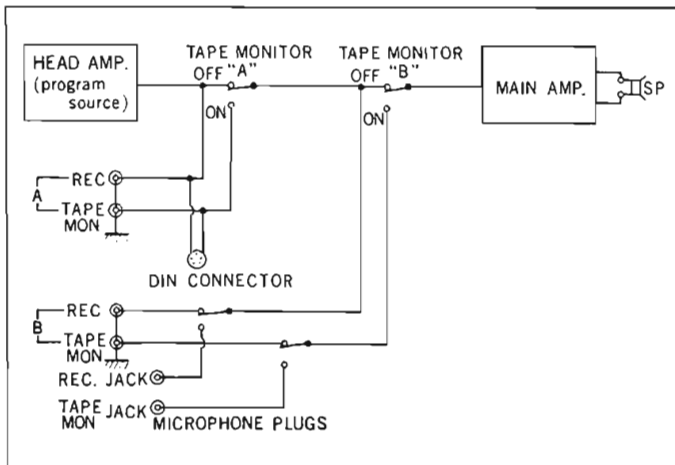

Signal Tape Recorder Operation

Depending on the type of tape recorder used, any of the four recorder terminals may be used for connection. The tape monitor switch on the front panel must correspond to the circuit used for monitoring or playback.

Operating Two or More Tape Recorders

Simultaneous recording, playback, mixing and other sophisticated techniques are possible with the 5000A with two or more tape recorders. A few basic examples:

** One program source can be simultaneously recorded by three tape recorders connected to circuits A and B. This is possible because there are three REC outputs on the amplifier and the monitor switch is not needed for recording purposes.

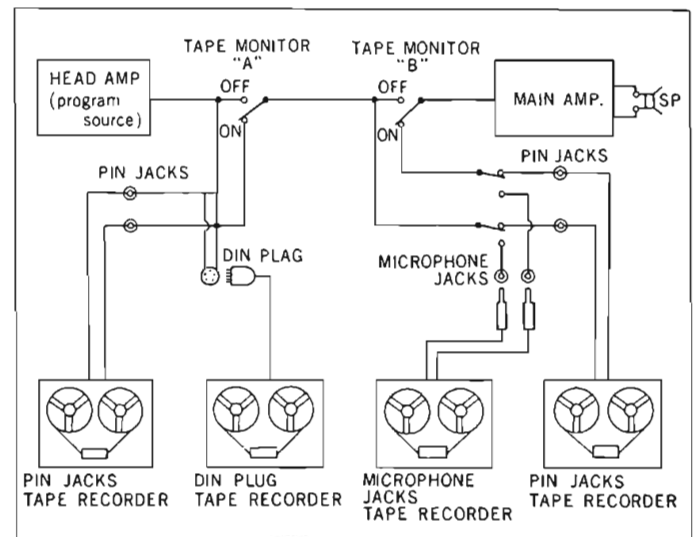



** Playback from a tape recorder connected to circuit A can be recorded by a recorder connected to circuit B, and monitored simultaneously. For playback or monitoring a tape in this case, the B tape monitor switch on the front panel of the amplifier should be pushed on. In all other cases, it should be kept off.

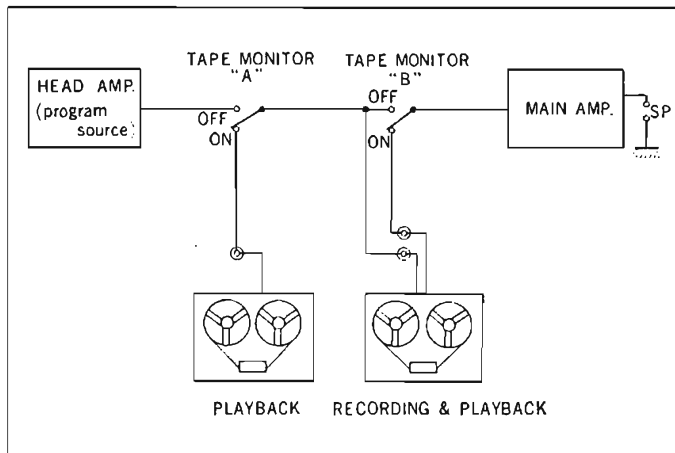

** Playback from two recorders connected to the A circuit can be mixed and recorded by a third recorder connected to circuit B, and monitored simultaneously. In this case, both tape monitor switches A and B on the front panel should be pushed on.

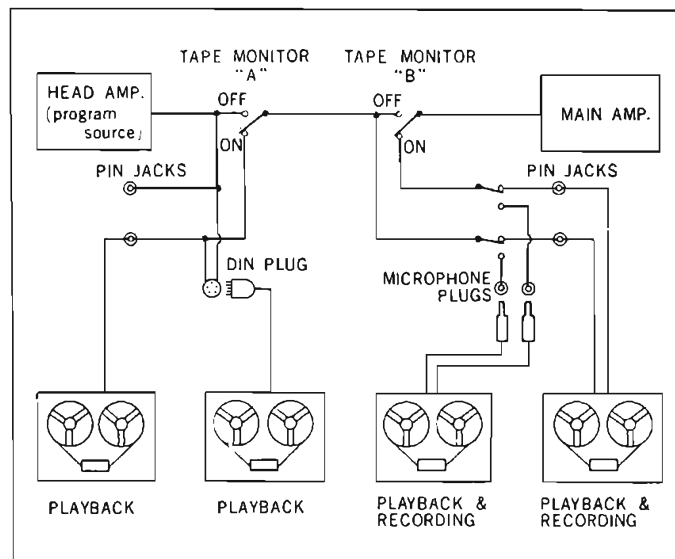

Tape Deck Operations

1. Set the FUNCTION Selector to the TAPE HEAD position on the front panel of the amplifier. The TAPE HEAD indicator will light up blue.
2. Turn on the power supply for the tape deck.
3. If a monaural tape deck is used, push the MONO switch on.
4. Adjust the BALANCE control to obtain equal sound from both right and left channels.
5. Use all other controls and switches according to taste and listening conditions.

NOTE:

1. Tape recorded sound cannot be controlled by the switches and controls on the front panel of the amplifier. They control sound from the speakers only.
2. For better results, record directly through the 5000A, rather than through microphones placed in front of the speakers.
3. Tape recorders referred to in this section include only those with built-in playback pre-amplifiers. Those without should be connected and operated as tape decks.
4. Tape monitoring is possible only with 3-head tape recorders, i.e., those with separate playback and recording heads.

MAINTENANCE

How to Eliminate Radio Noise

AM Reception

AM reception noise can often be eliminated by changing the position of the antenna. If you are located far from the broadcasting station, or in the mountains, a thick-walled building or a block of such buildings, radio waves will not be well received, resulting in unstable reception and increased noise. If reception is poor, connect a vinyl wire (supplied) to the AM antenna terminal and position it for best reception. If this does not reduce noise or improve sensitivity, erect an antenna outside the building and apart from the wall. This switch is located behind the AM ferrite bar antenna on the back panel of 5000A. Some noises are peculiar to a certain broadcasting frequency or a certain time of day. These result from the nature of AM signals. In some cases the noise can be eliminated by grounding the amplifier or reversing the power-cord plug receptacle connections.

NOTE: If the antenna terminal marked A is touched with a finger, a hum may be heard. This is a natural phenomenon; the unit is not at fault.

FM Reception

Noise during FM reception can be generally attributed to either insufficient antenna input or interference from other electrical appliances.

Antenna input is insufficient when the antenna is not installed properly or when the station is far away. Extend and fix the attached antenna so that noise is minimized and the antenna input is at maximum. For better results, install an exclusive FM antenna in a position to receive signals most effectively.

If you use a T.V. antenna for the T.V. set and the FM unit with a divider, make sure that the television reception is not affected. To prevent noise, avoid using a long antenna wire.

FM reception is affected considerably by the transmitting conditions of certain stations; usually their power and antenna efficiency. You may receive one station quite well and another poorly. To eliminate interstation tuning noise, push the Muting switch.

Noise Common to FM and AM

In an area with many ferroconcrete buildings, noise may occur at a particular time of day. This noise is easily distinguished from that described above. To eliminate such noise, attach a noise arrester to the interfering electrical appliance or to the power source of the 5000A. When you are listening to a FM-MPX program, you may notice a noise not heard with monophonic FM broadcasts. The unit is not at fault, just push the High Filter switch to eliminate the noise. In some cases, you can also eliminate the noise by setting the Treble control to "flat" or lower.

Listening to FM-MPX Stereo Programs Monaurally

In areas remote from broadcasting stations, FM-MPX broadcasts may be accompanied by noise that is not noticeable with regular FM monaural broadcasts. This is because the stereo broadcast wave has a service area only half as long as the monaural wave. If the noise accompanying a stereo broadcast cannot be suppressed satisfactorily by using the HIGH filter or by adjusting the TREBLE control to a flatter level, set the FUNCTION Selector to the FM position and listen to the same broadcast monaurally.

Output Control Volume

The 5000A offers a full 180 watts in power output, often more than is needed for the average speaker system. To protect speakers from becoming damaged should the 5000A be operated at full power, this control limits the maximum volume of the amplifier. Turn the screw counterclockwise with a small screw driver to adjust the 5000A's output to the input level of the speaker system. The VOLUME Control on the front panel then adjusts sound volume only within this range.

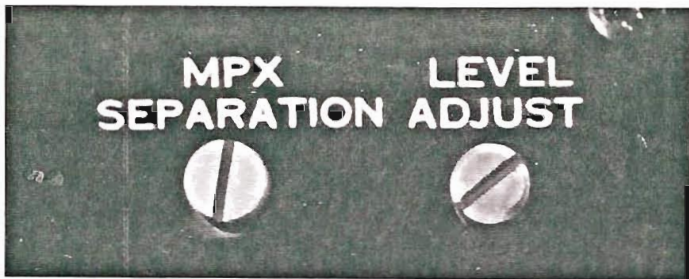

FM-MPX Separation

If the channel separation during FM-MPX stereo reception becomes inadequate or excessive, turn the screw marked MPX SEPARATION on the rear panel of the amplifier for natural proportions. Never attempt turn it without reason as it has been properly adjusted prior to leaving our factory.

Local-Distant Antenna Switch

This switch adjusts the tuner to the strength of FM radio waves. It should be set to DIST if the receiver is located in an area where FM signals are weak, and to LOC if it is located near broadcasting stations and there is danger of interstation interference.



Damping Factor Switch

This switch enables one of two damping factors to be selected to match the type of speaker system used. Set it to either its HIGH (DF 50) or LOW (DF 15) position while actually listening to the speakers in operation.

Voltage Selecting Plug

This plug is located inside the bonnet of the amplifier and has been set to the voltage of your area prior to shipment. If the amplifier is ever moved to an area with another voltage requirement, this plug must be changed to the proper voltage of the new area. To change, remove the bonnet from the amplifier (see Service Manual), remove the plug from the voltage socket you have been using, and plug the arrow head into the appropriate voltage requirement of 100V, 117V, 220V and 240V.

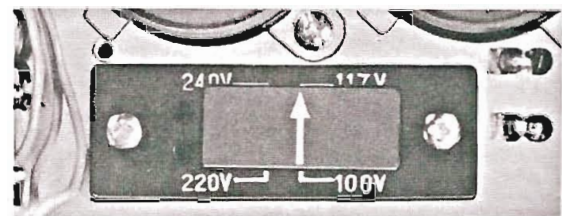

MAINTENANCE

Grounding

Connect one end of vinyl or enameled wire to the terminal screw marked GND at the rear of the amplifier, attach a copper plate to the other end, and burn it underground. Whenever an outdoor AM antenna is used, grounding becomes necessary. In all cases, grounding is desirable since it allows a better S/N ratio to be obtained. To ground an entire audio system, connect the grounding wire of each component used to this terminal.

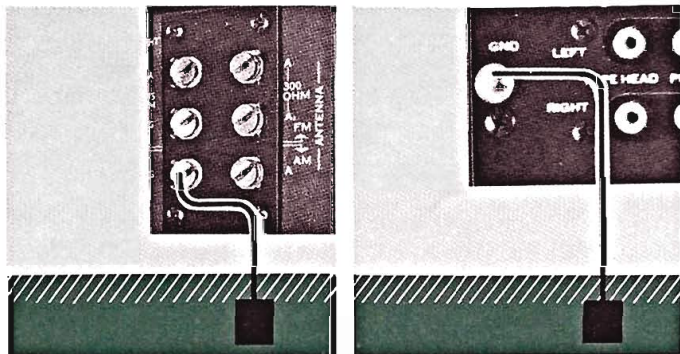

If the Protector Lights Up . . .

It means that 5000A's circuit has been activated to cut incoming current as soon as it exceeds the allowable limit to prevent the power transistors from becoming damaged. When this happens, the PROTECTOR lamp to the right of the TUNING knob lights up in red and is accompanied by an instant decrease in sound volume. As soon as this happens, turn off the amplifier's power supply for about five seconds, then turn it back on. If the PROTECTOR lamp lights up again, immediately turn the power off, locate and eliminate the source of trouble. Probable cause: a shorted output circuit.



Quick-Acting Fuses

These fuses for right and left channels are also designed to protect the transistors by blowing instantly if shorting occurs between connections at a speaker system terminal. If, after the POWER switch is turned on and the function indicator lights up, neither channel operates or only one operates normally, is either because one or both Quick-Acting fuses have blown. In this case, remove the 5000A's power supply cord from its outlet, screw out the fuse holders on the rear panel, and check to see if the fuses are blown. Replace them with identical 5A fuses after finding and eliminating the source of trouble that caused them to blow.



Wire Connections

When connecting recorders, players or other components to the 5000A, be sure to use shielded wire. The use of an ordinary cord or vinyl wire may cause humming and buzzing. The length of the shielded wire used should be shorter than 5 feet. Be sure that all lead wires between the amplifier and components are properly connected. If the connections are loose or in touch with other parts, the amplifier will not function properly, may pick up noise, and even breakdown over a period of time. Also, be sure

to read the manufacturer's instructions for any component before connecting it to the 5000A.

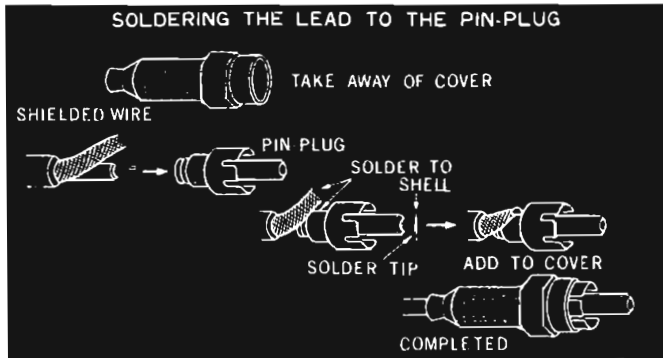

AC Outlets

Two AC outlets have been provided on the rear panel of the amplifier to serve as power supply sources for tape recorders, players or other components used with the 5000A. The outlet left (SWICH-ED) is controlled by the POWER switch on the front panel of the amplifier.



Power Fuse

Should the amplifier fail to operate and the function indicator fail to light up when the POWER switch is turned on, the probable cause is either a power stoppage or a blown fuse. To check, remove the 5000A's power supply cord from its outlet, turn the fuse holder on the rear panel counterclockwise, and remove the fuse. If it is blown, replace it with a new glass-tubed fuse of the same capacity (5A) after

determining and eliminating the trouble source that caused the fuse to blow. Using wire or a fuse of a different capacity as a stop-gap measure is dangerous and should be avoided.

Should the Function Indicator Fail to Light ...

If one or more function indicators fail to light in the dial window when the FUNCTION Selector is switched to the appropriate position, it is most likely one or more indicator lamps behind the window have burnt out. To replace, remove the bonnet from the amplifier (see Service Manual). Two spare lamps are provided inside the amplifier cabinet.

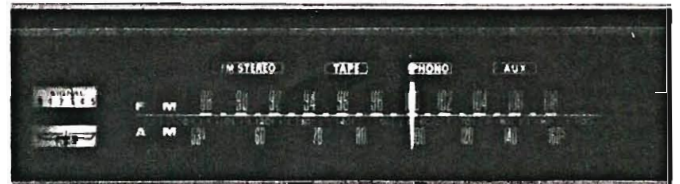
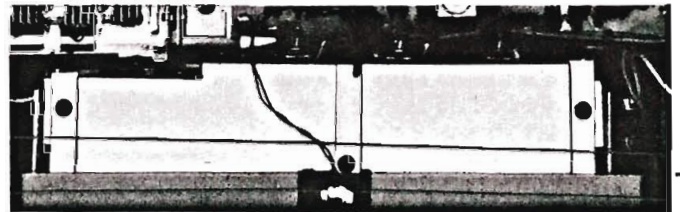

SPECIFICATIONS CHARACTERISTICS

AMPLIFIER SECTION

POWER OUTPUT

MUSIC POWER (IHF): 180W at 4 ohms
140W at 8 ohms

CONTINUOUS POWER (EACH CHAN.):
75W;75W at 4 ohms
55W;55W at 8 ohms

HARMONIC DISTORTION: less than 0.8% at rated output

POWER BANDWIDTH (IHF): from 15 to 30,000 Hz at 8 ohms

FREQUENCY RESPONSE (at listening level)

POWER AMPLIFIER SECTION: from 10 to 50,000 Hz
 ± 1.0 dB

AUX: from 20 to 30,000 Hz ± 1.5 dB

INPUT SENSITIVITY (for rated output)

PHONO: 2.5 mV

TAPE HEAD: 2.0 mV

AUX: 150 mV

TAPE MONITOR (PIN): 200 mV

TAPE MONITOR (DIN): 200 mV

RECORDING OUTPUT

REC OUT (PIN): 200 mV

REC OUT (DIN): 40 mV

HUM AND NOISE (below rated output)

VOLUME MINIMUM: better than 80 dB

PHONO: better than 65 dB

AUX: better than 70 dB

CHANNEL SEPARATION (at rated output)

PHONO: better than 50 dB

AUX: better than 50 dB

OUTPUT IMPEDANCE: from 4 to 16 ohms

DAMPING FACTOR: 15 and 50 (at 8 ohms)

EQUALIZER

PHONO: RIAA, NF type

TAPE HEAD: NAB, NF type

CONTROLS AND SWITCHES

BASS CONTROL: from +11 dB to -11 dB at 50 Hz

TREBLE CONTROL: from +12 dB to -12 dB at 10,000 Hz

LOUDNESS CONTROL: +8 dB at 50 Hz, +4 dB at 10,000 Hz (Volume control at -30 dB)

LOW FILTER: -10 dB at 50 Hz

HIGH FILTER: -10 dB at 10,000 Hz

MODE SWITCH: STEREO NORM, STEREO REV. STEREO, MONO

SELECTOR SWITCH: 1. TAPE HEAD 2. PHONO
3. AM 4. FM 5. FM AUTO
6. AUX

SPEAKER SWITCH: 1. OFF 2. A SYSTEM
3. B SYSTEM 4. C SYSTEM
5. A+B SYSTEM 6. A+C SYSTEM

POWER BANDWIDTH

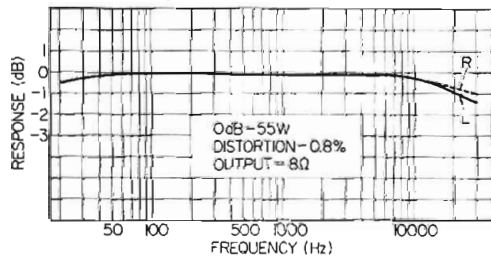

TONE CONTROL

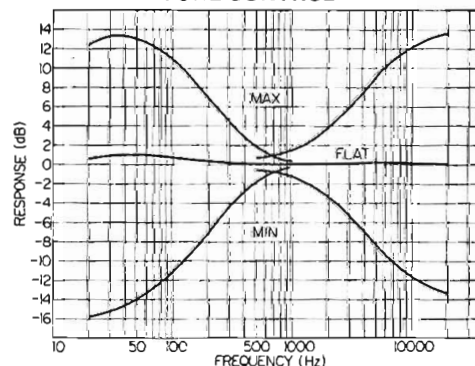

CAPTURE RATIO (IHF)

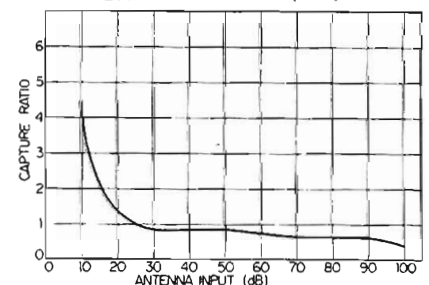

OTHER SPECIAL FEATURES

2 Channel Tape Monitor, DIN Connector, Headphone Jack, 3 Speaker System Selector Switch, level adjuster, Selector indicator, Protection circuit, Protection Indicator, Damping Factor control switch

TUNER SECTION

FM

FREQUENCY RANGE: from 88 to 108 MHz
SENSITIVITY: 1.4 μ V (20 dB quieting)
 1.8 μ V (IHF)
HARMONIC DISTORTION: less than 0.5%
SIGNAL TO NOISE RATIO: better than 65 dB
SELECTIVITY: better than 50 dB at 98 MHz
CAPTURE RATIO: 1.5 dB (IHF)
IMAGE FREQUENCY REJECTION: better than 90 dB at 98 MHz
IF FREQUENCY REJECTION: better than 100 dB at 98 MHz
FM STEREO SEPARATION: better than 35 dB
SPURIOUS RESPONSE REJECTION: better than 95 dB at 98 MHz
SPURIOUS RADIATION: less than 34 dB
ANTENNA INPUT IMPEDANCE: 300 ohms balanced and 75 ohms unbalanced

AM

FREQUENCY RANGE: from 535 to 1,605 kHz
SENSITIVITY (IHF): 15 μ V at 1 MHz
IMAGE FREQUENCY REJECTION: better than 50 dB at 1 MHz
IF FREQUENCY REJECTION: better than 80 dB at 1 MHz
SELECTIVITY: better than 20 dB at 1 MHz

OTHER SPECIAL FEATURES

IC IF Unit FET FM Front End FM Stereo Only Switch, FM Muting, Dual tuning Meter, FM Stereo indicator, Heavy fly-wheel tuning, AM Ferrite bar antenna, Stereo auto, FM SCA Filter FM Local/Distant switch

TRANSISTORS AND DIODES

TRANSISTORS, FET and IC: TR; 52, FET; 3, IC; 4
DIODES: D; 33, Zener D; 3
VARISTORS: 4
SCR: 1

POWER REQUIREMENTS

POWER VOLTAGE: 100, 117, 220, 240, Volt, from 50 to 60 Hz
POWER CONSUMPTION: 210 VA (max) 380 VA (with A.C. outlet)

DIMENSIONS (without, rubber stands)

WIDTH: 17 ¹¹/₃₂"
HEIGHT: 4 ¹⁷/₃₂" (without rubber stands)
DEPTH: 14 ⁹/₁₆"
WEIGHT: 29.1 lbs

FM STEREO SEPARATION

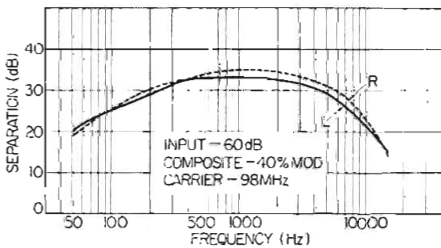

FM SENSITIVITY & IMAGE RATIO

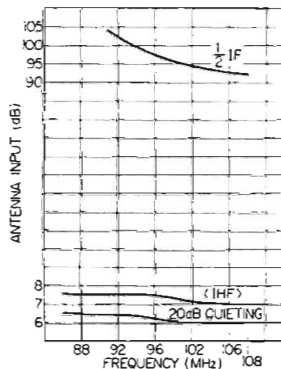

FM SIGNAL TO NOISE RATIO, OUTPUT LEVEL VS ANTENNA INPUT, DISTORTION & AMPLITUDE MODULATION SUPPRESSION RATIO

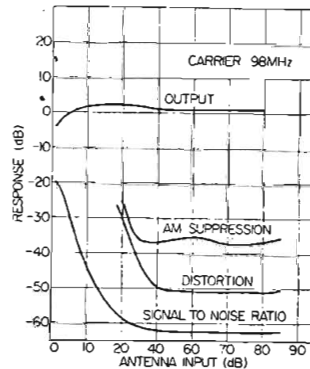

AM SENSITIVITY & IMAGE RATIO

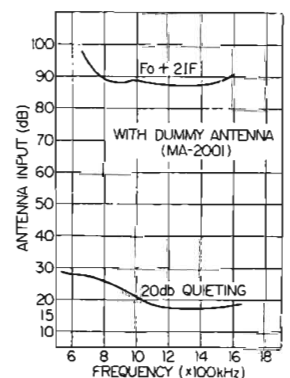



Sansui[®]



SANSUI ELECTRIC COMPANY LIMITED



Head Office; 14-1, 2-chome, Izumi, Suginami-ku, Tokyo, Japan. TEL. 323-1111

Printed in Japan (49051M)